



38A Michelin MXV tire

38B Wheel rim

38C Hub cover

38D Washer

KM M2,3 x5x5,5 ( x2 )

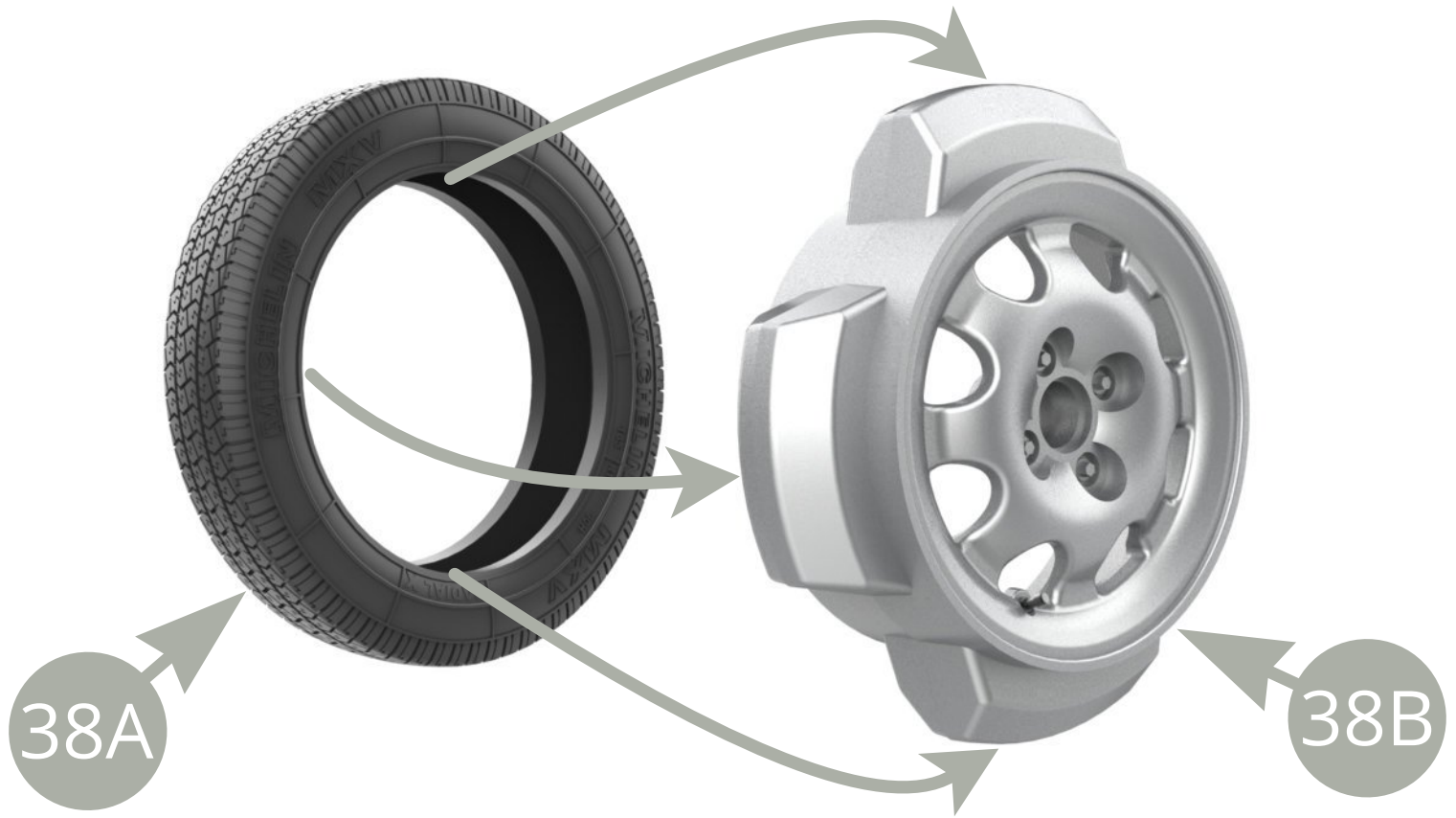

Put **38A Michelin MXV tire** for **two minutes** into **hot water** , for softening , and then fit it over **38B Wheel rim** .

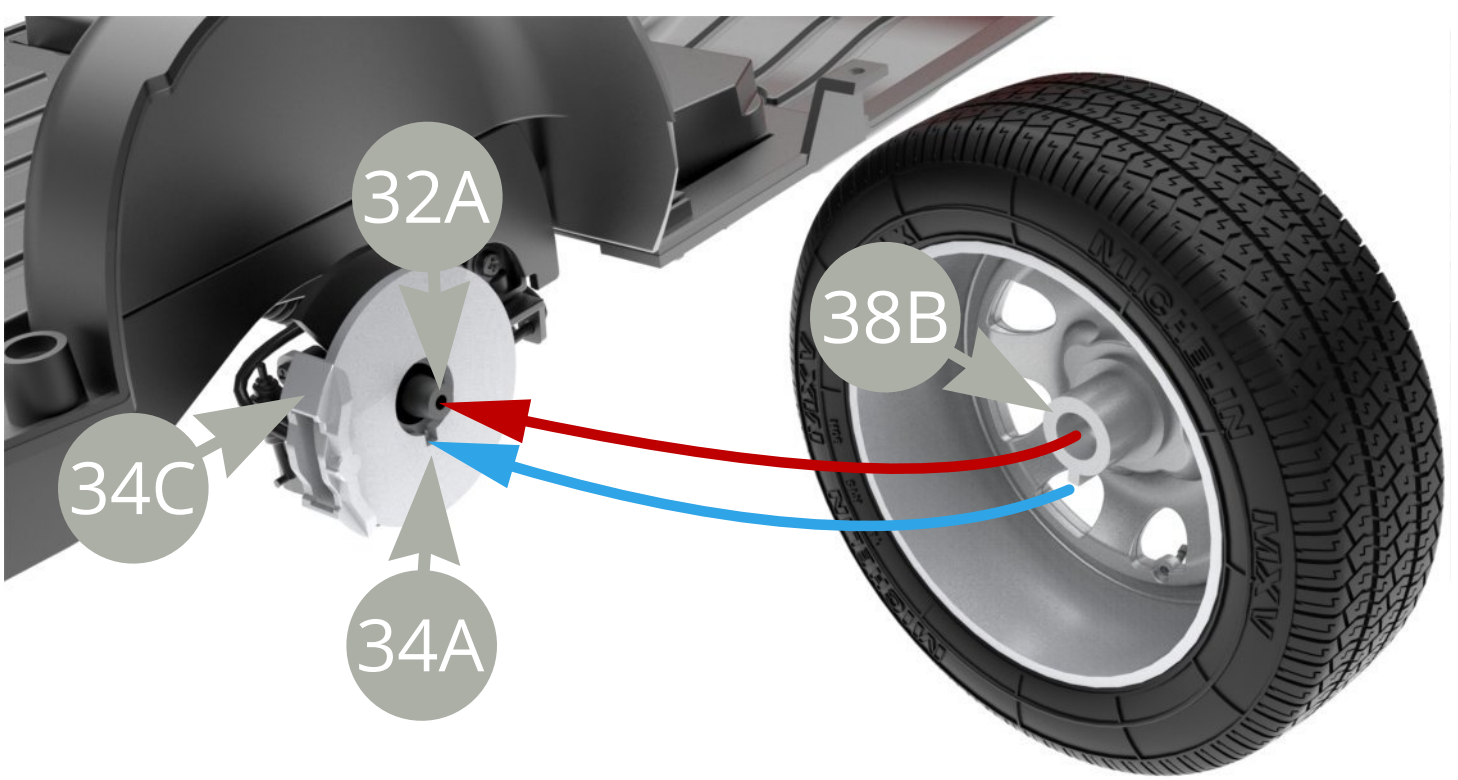

Fit **34A Brake disc** on **32A Rear axle** ( entering also into **34C Brake caliper** ), and then fit **38B Wheel rim** inner hub on **32A Rear axle** , engaging its key into notch on **34A Brake disc** ( **blue arrow** ) .

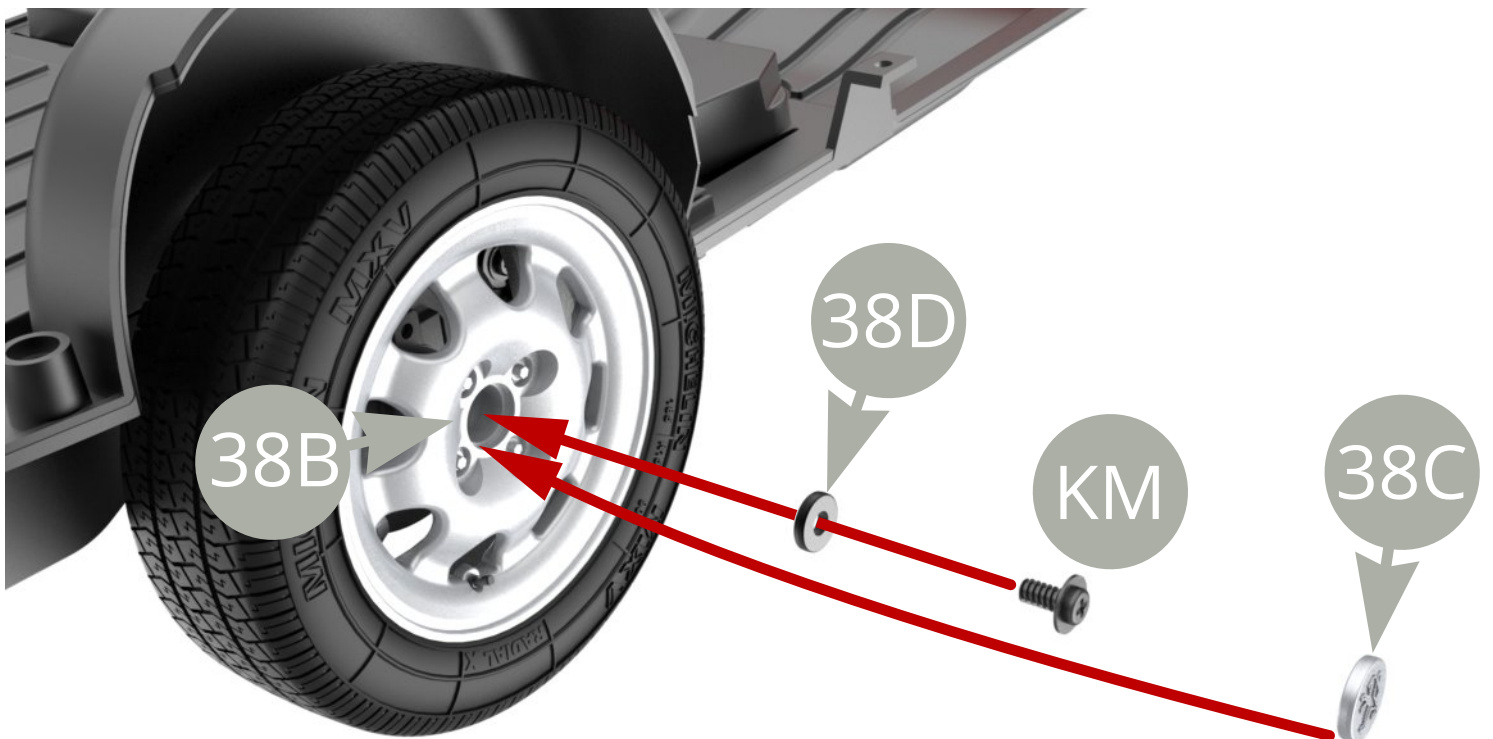

Fix **38B Wheel rim** with **KM screw** via **38D Washer** .  
Fit **38C Hub cover** to **38B Wheel rim** .

Final views .

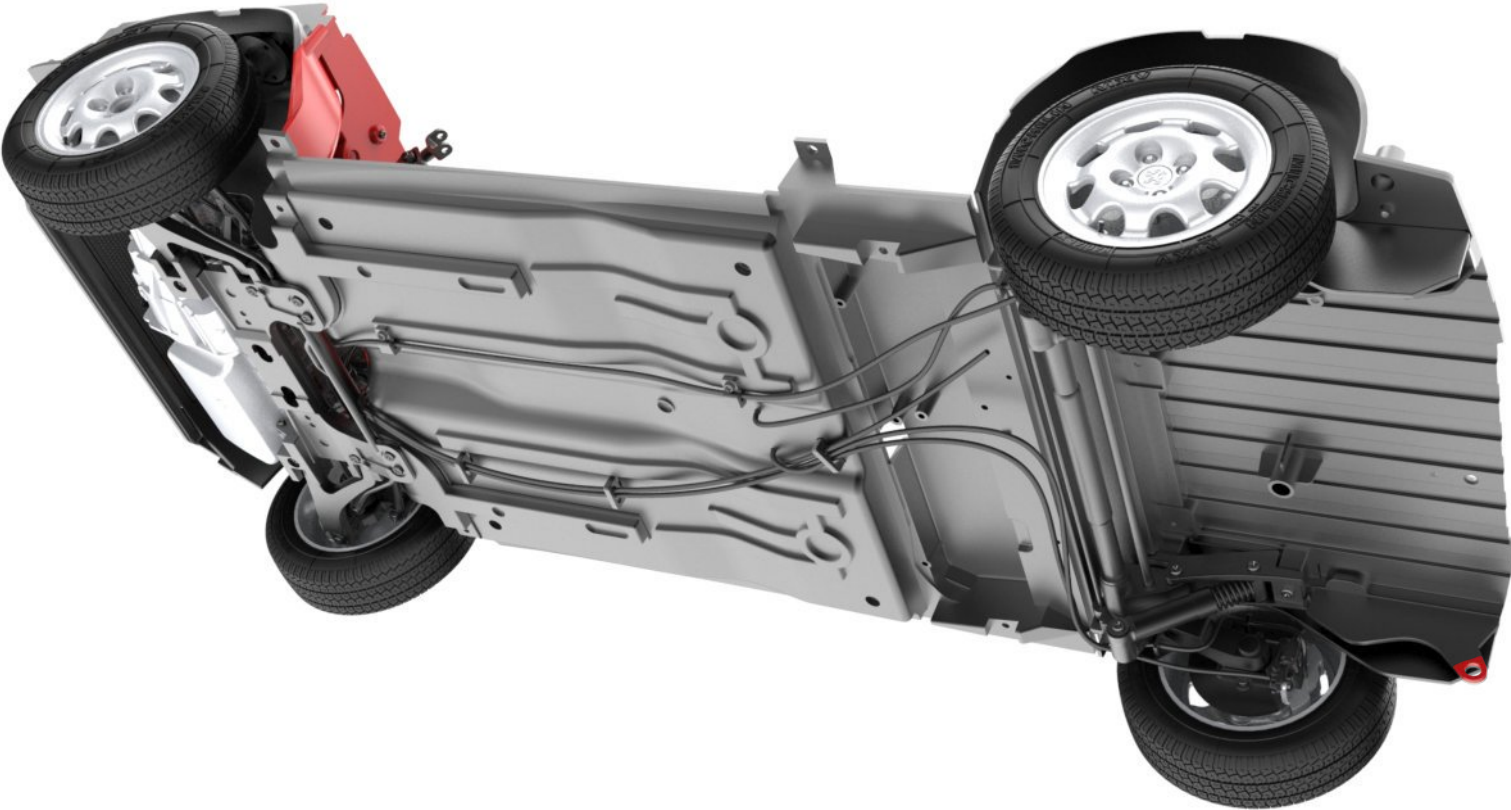

# Assembly drawings

