

61A Instrument console

61B Instrument screen

61C Instrument back plate

61D Cigar lighter

61E Optional button plug

61F Instrument panel LED cable J (**red - green**)

AP M1,7 x4mm (x5)

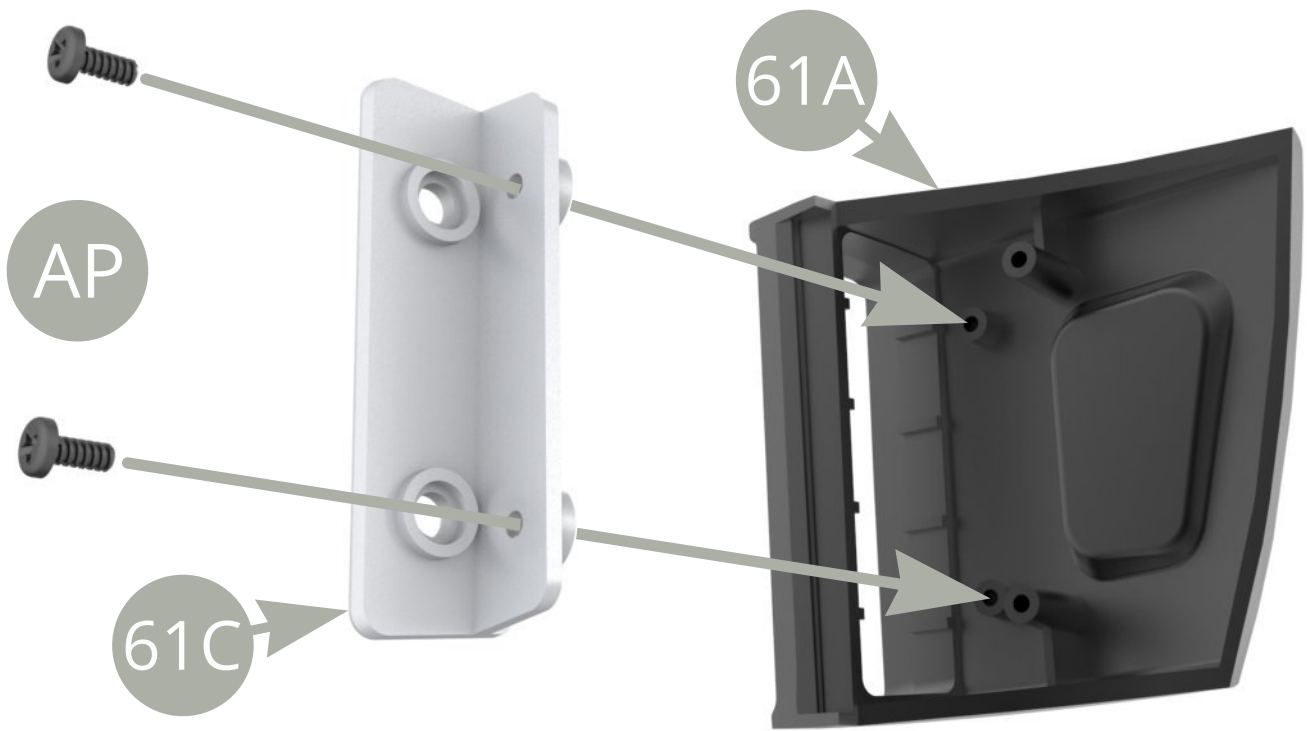

Fit **61C Instrument back plate** to **61A Instrument console** and fix with two **AP screws** .

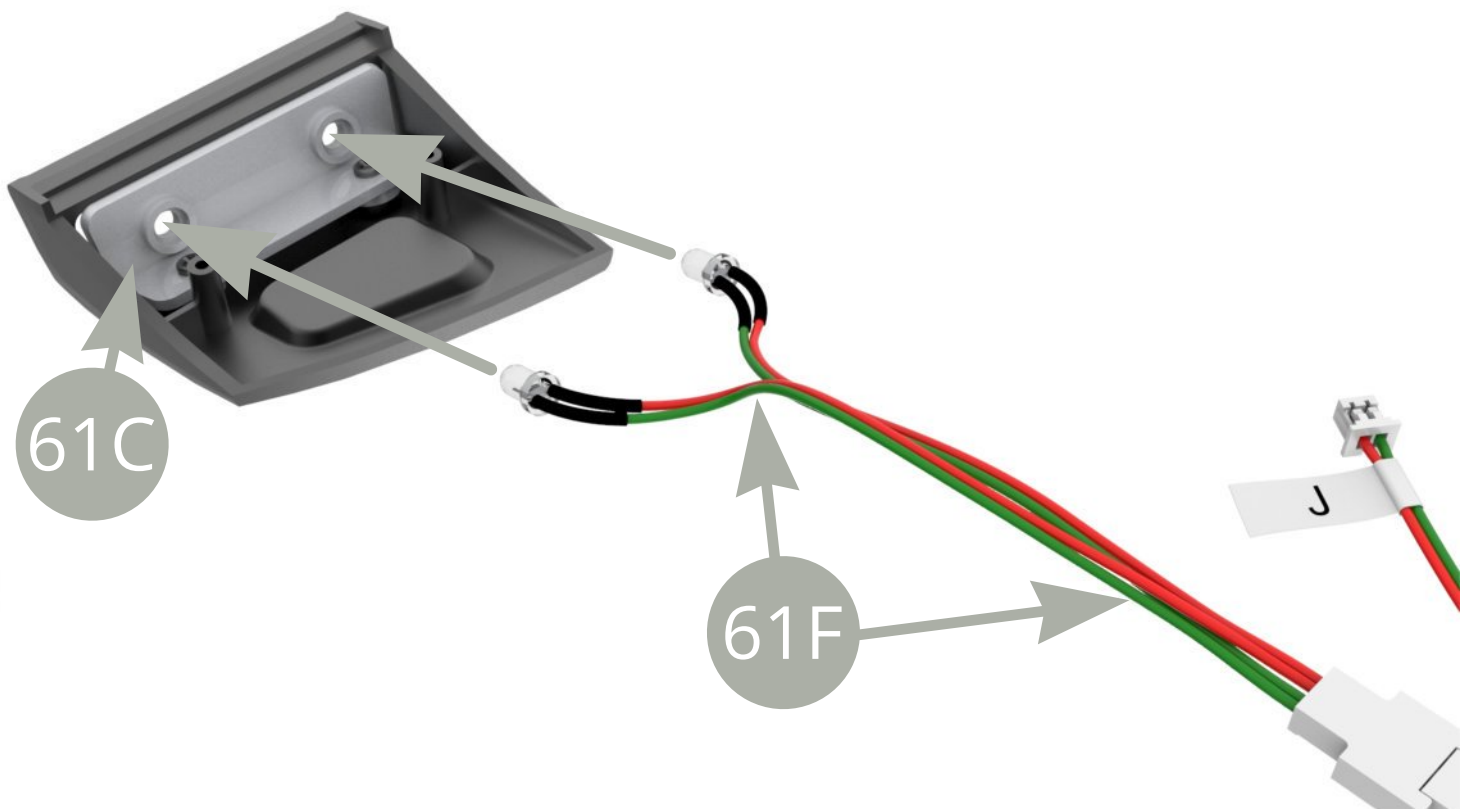

Fit two LEDs lamps of **61F Instrument panel LED cable J (red-green)** in **61C Instrument back plate sockets** .

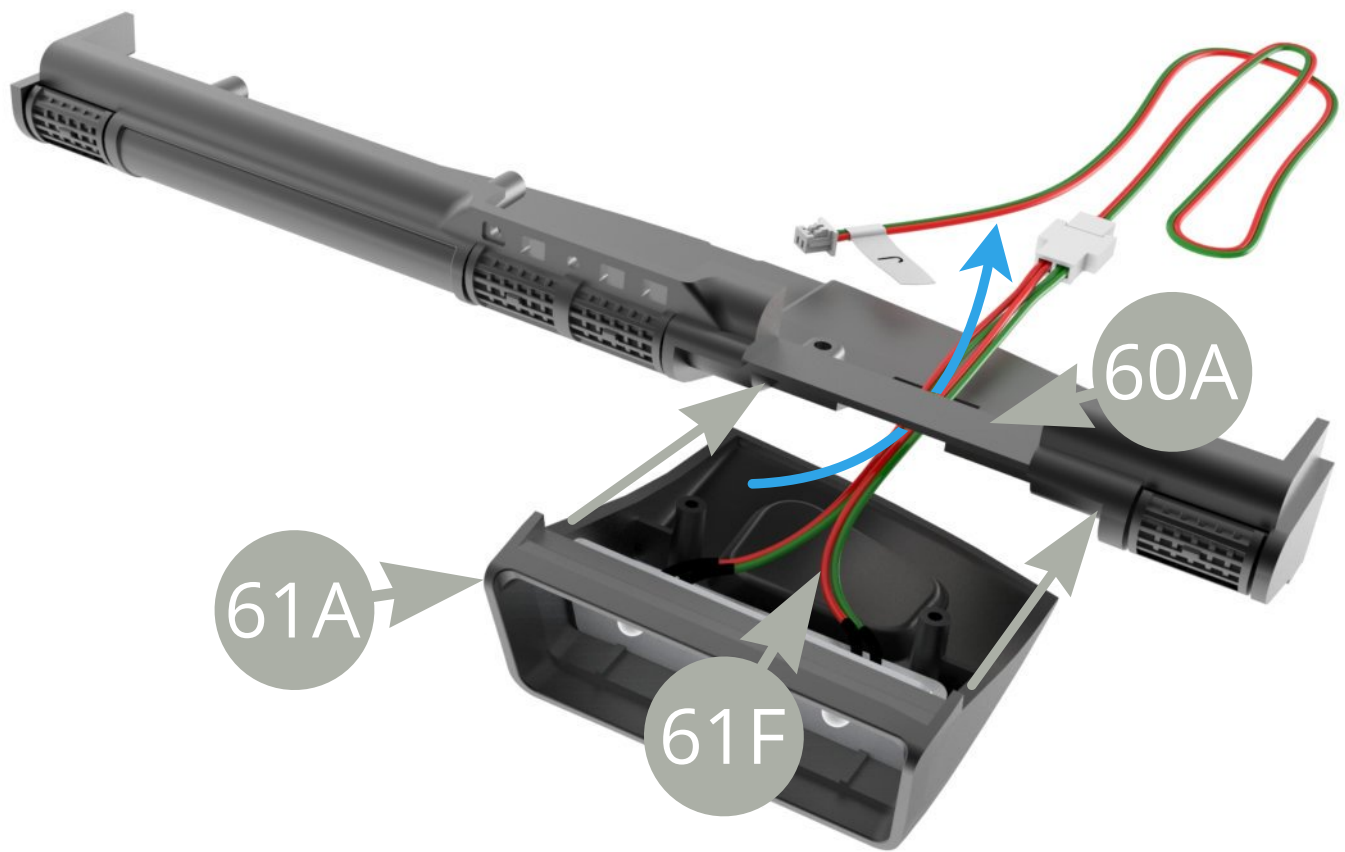

Pass **61F Instrument panel LED cable J** (**red - green**) through square opening in **60A Upper dashboard panel** (**blue arrow**).

Fit **61A Instrument console** to **60A Upper dashboard panel** and fix with two **AP screws** . (upper and lower illustrations)

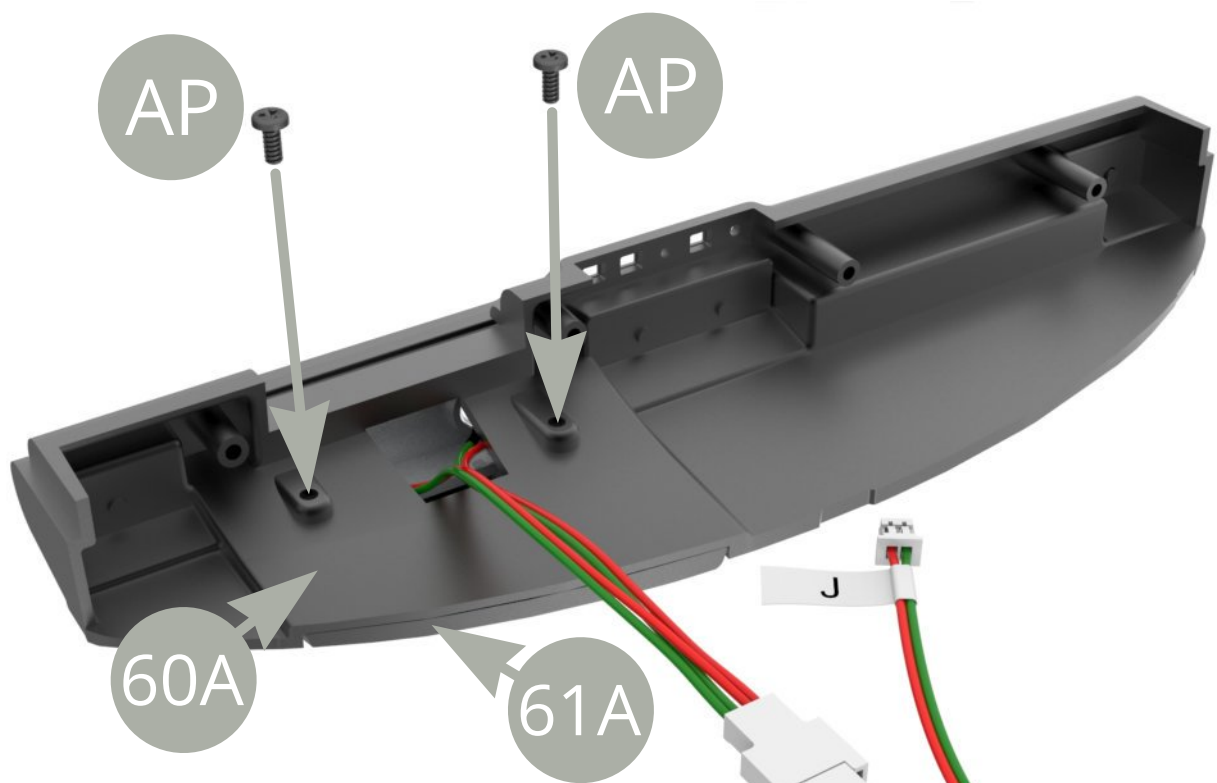

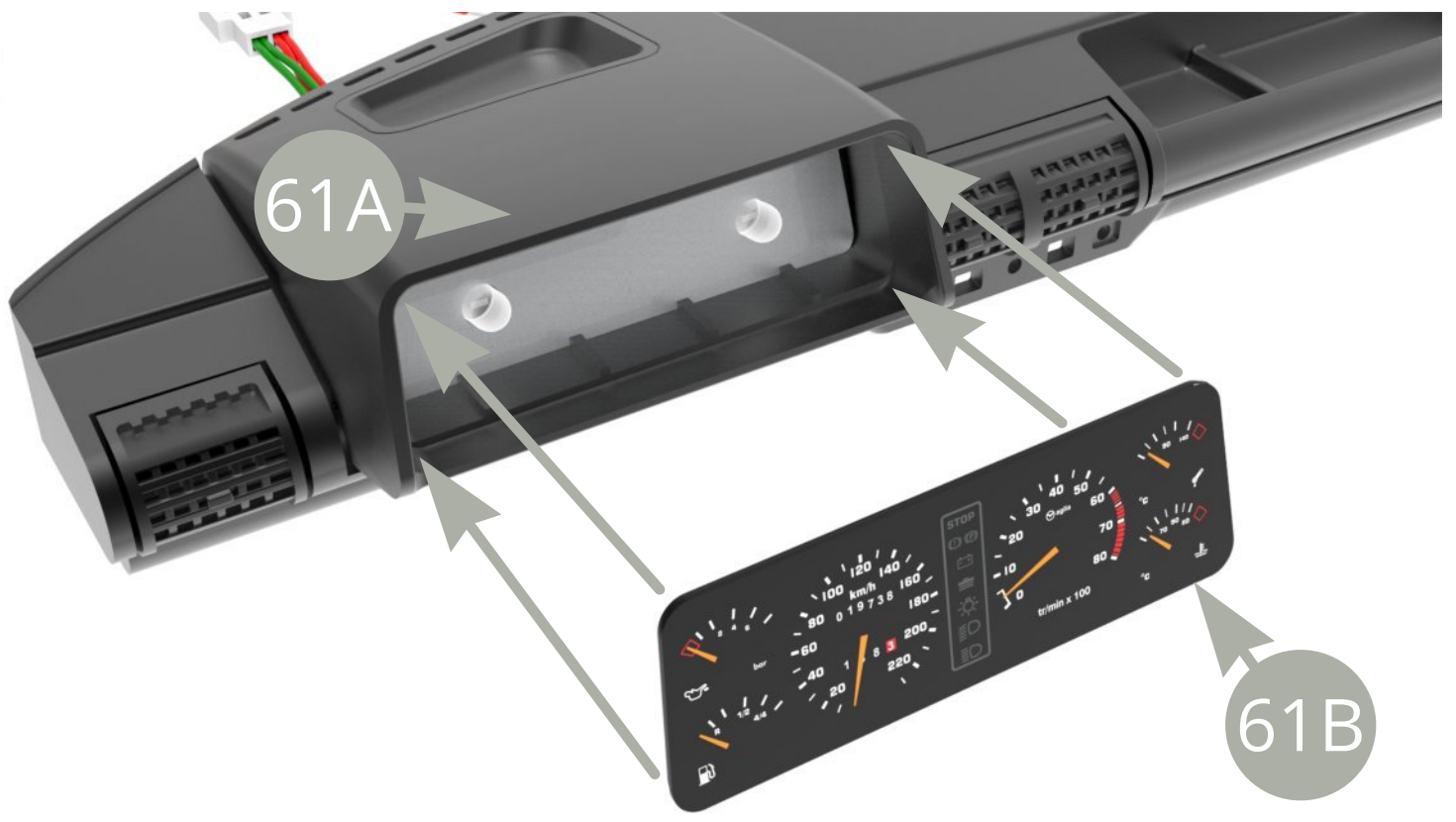

Fit **61B Instrument screen** to **61A Instrument console** .

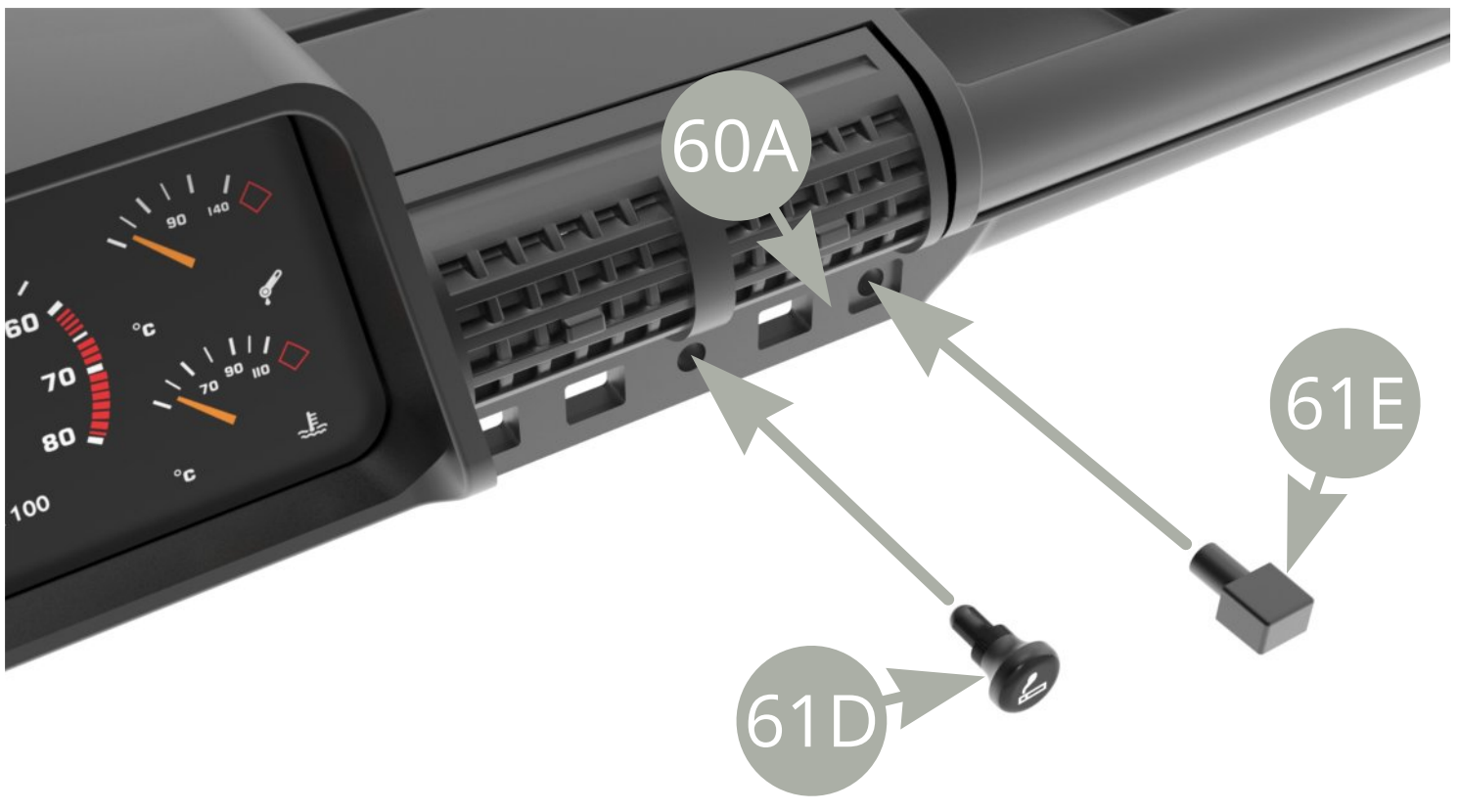

Fit **61D Cigar lighter** and **61E Optional button plug** to **60A Upper dashboard panel sockets** .



61D Cigar lighter and **61E Optional button plug** installed on **60A Upper dashboard panel** .

Final views .

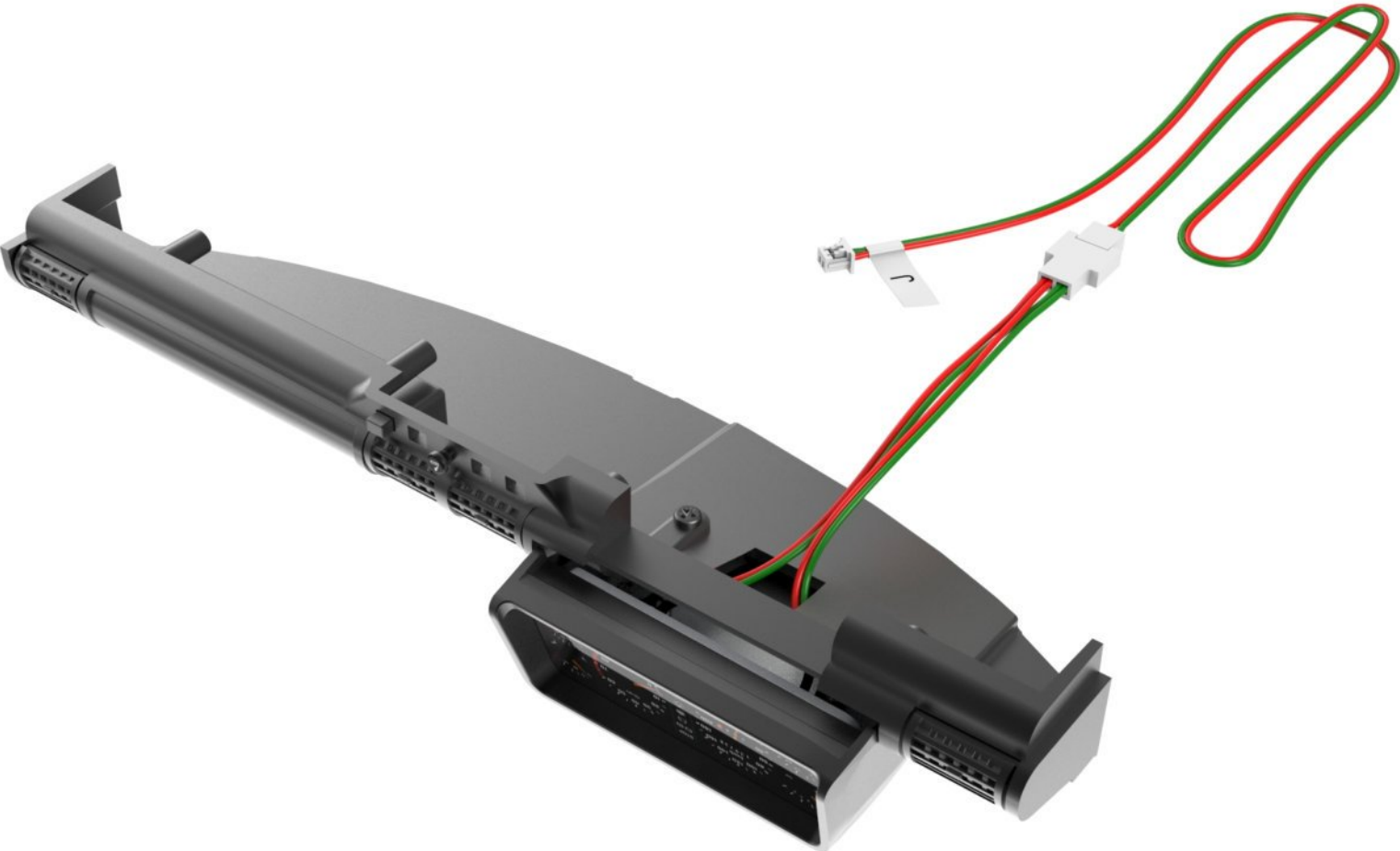

Assembly drawing.

