

80A Ceiling panel

80B Assist handle ( x3 )

80C Interior lamp cable F

80D Tape ( x3 )

HP M1,5 x3mm ( x7 )

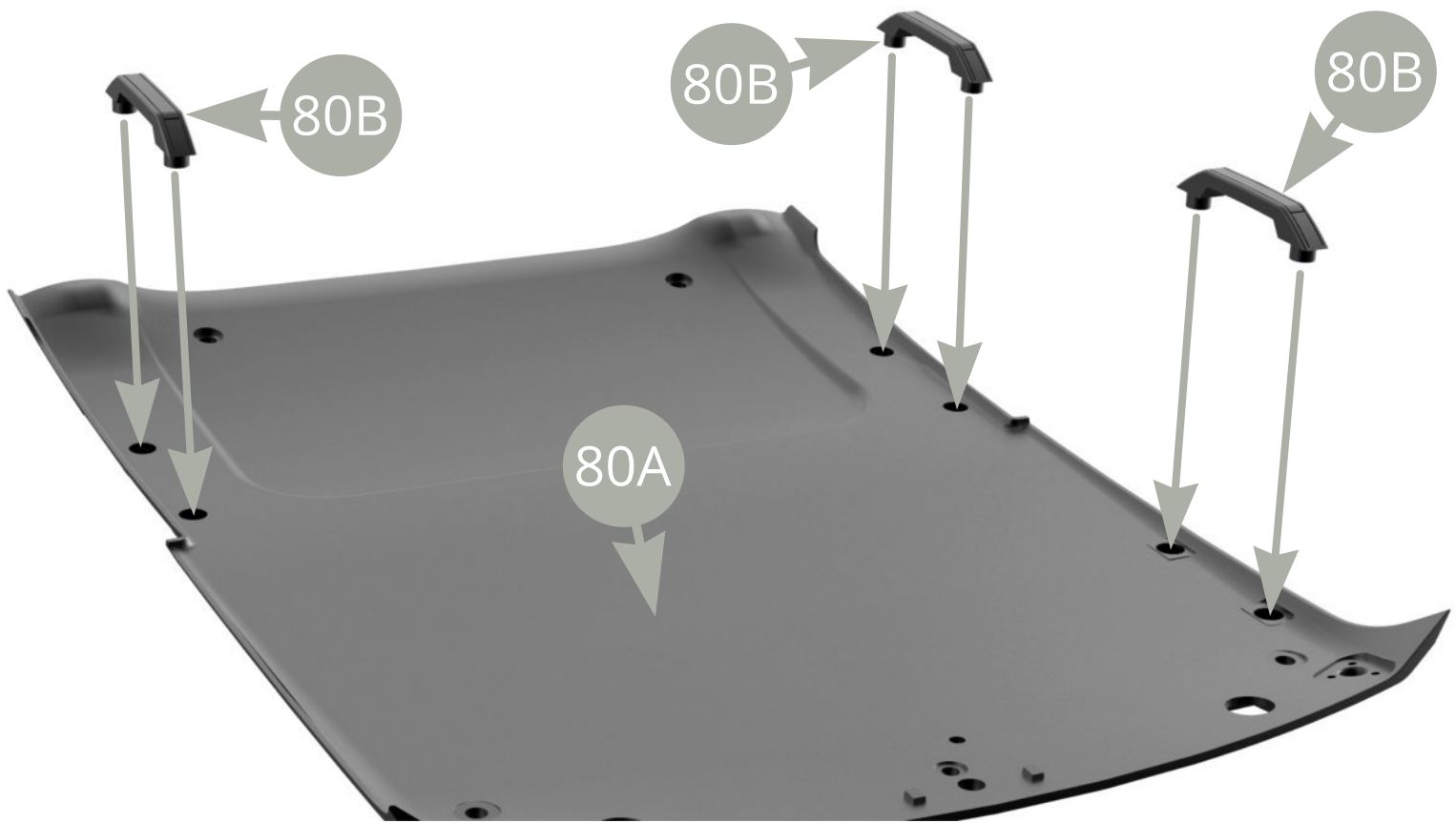

One by one , fit three **80B Assist handles** to **80A Ceiling lining** and fix each one with two **HP screws** ( upper and lower illustrations ) .

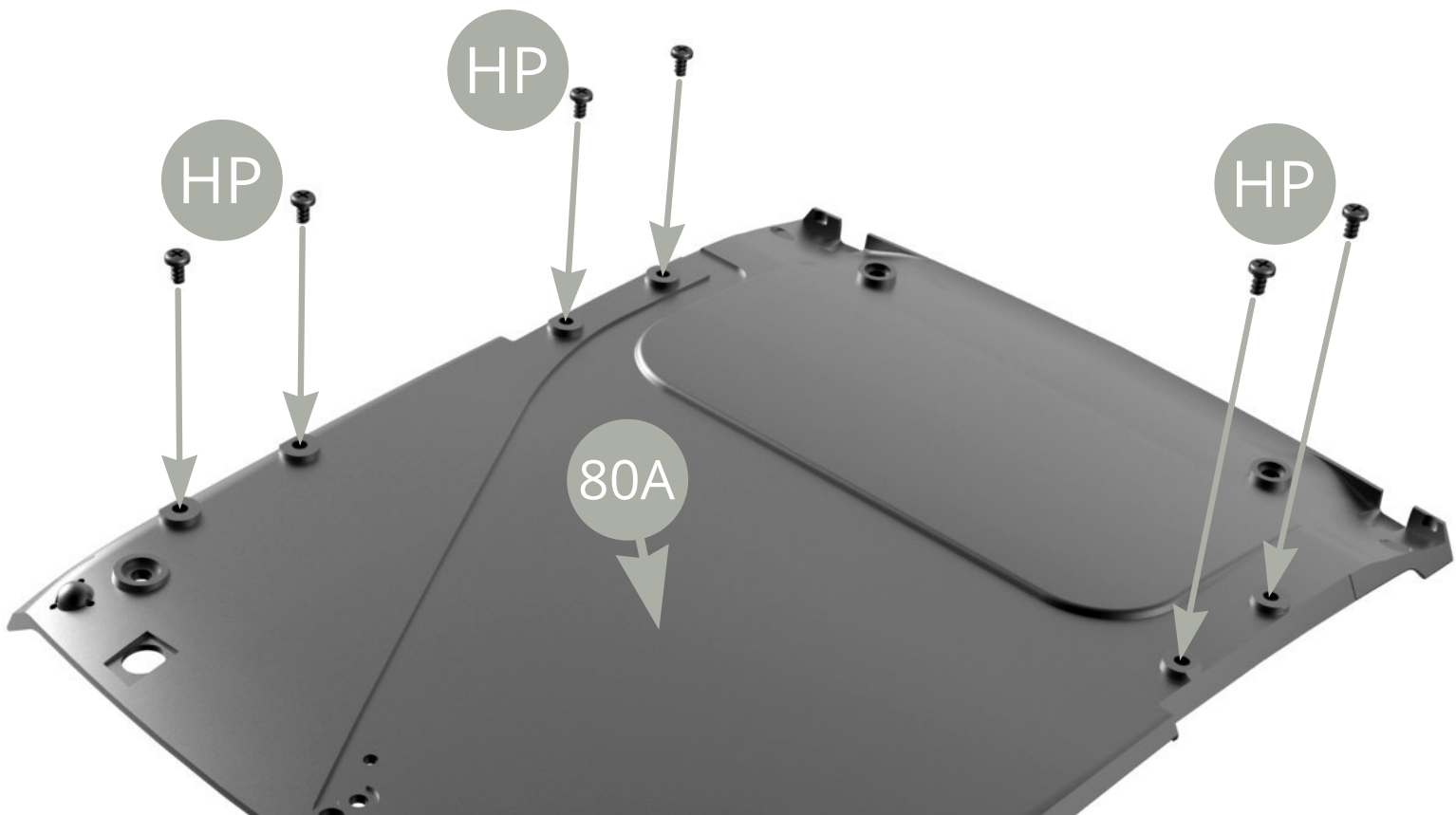

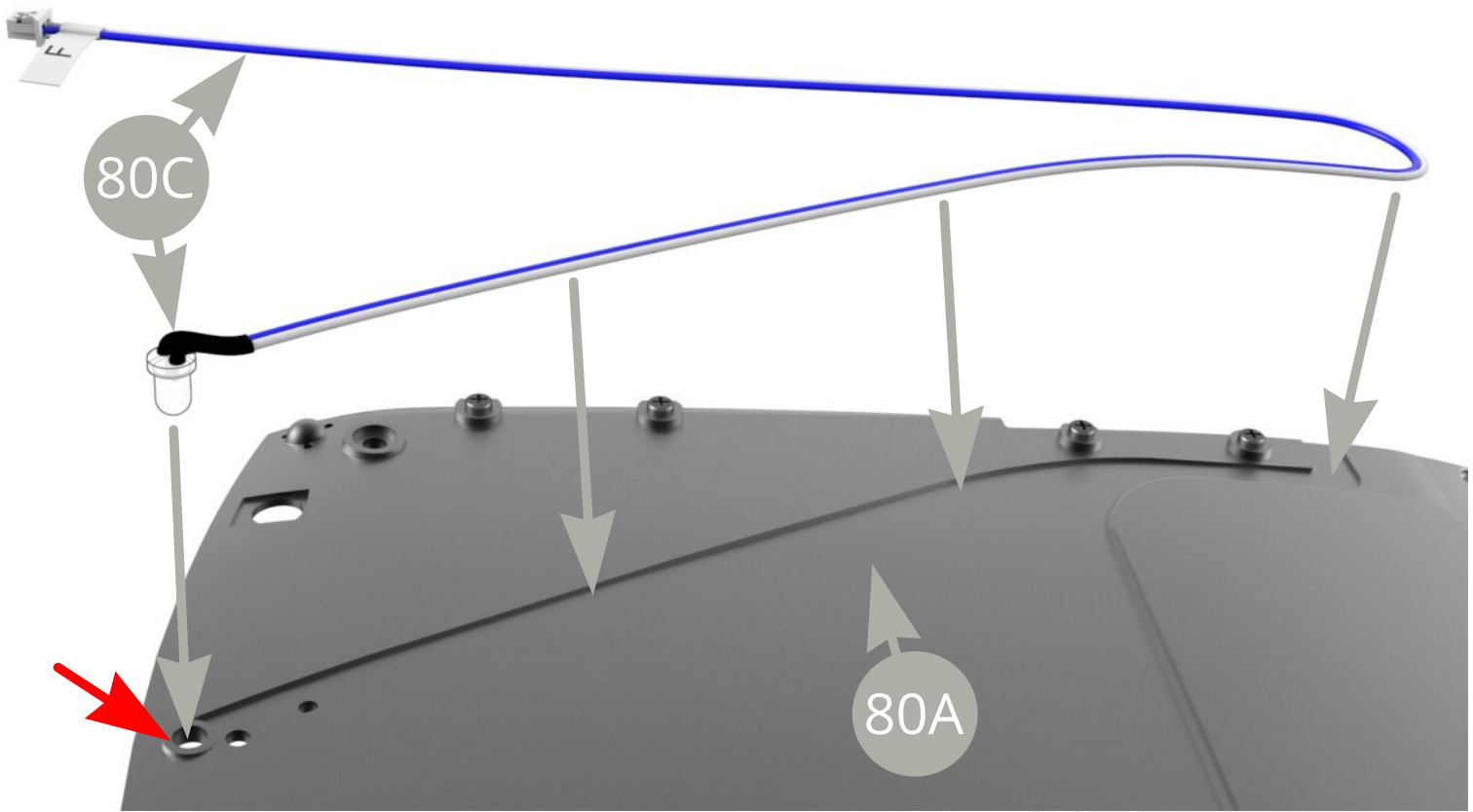

Fit **80C Interior lamp LED** into **80A Ceiling lining** socket ( **red arrow** ), check it showing on the opposite side ( upper and lower illustrations ).

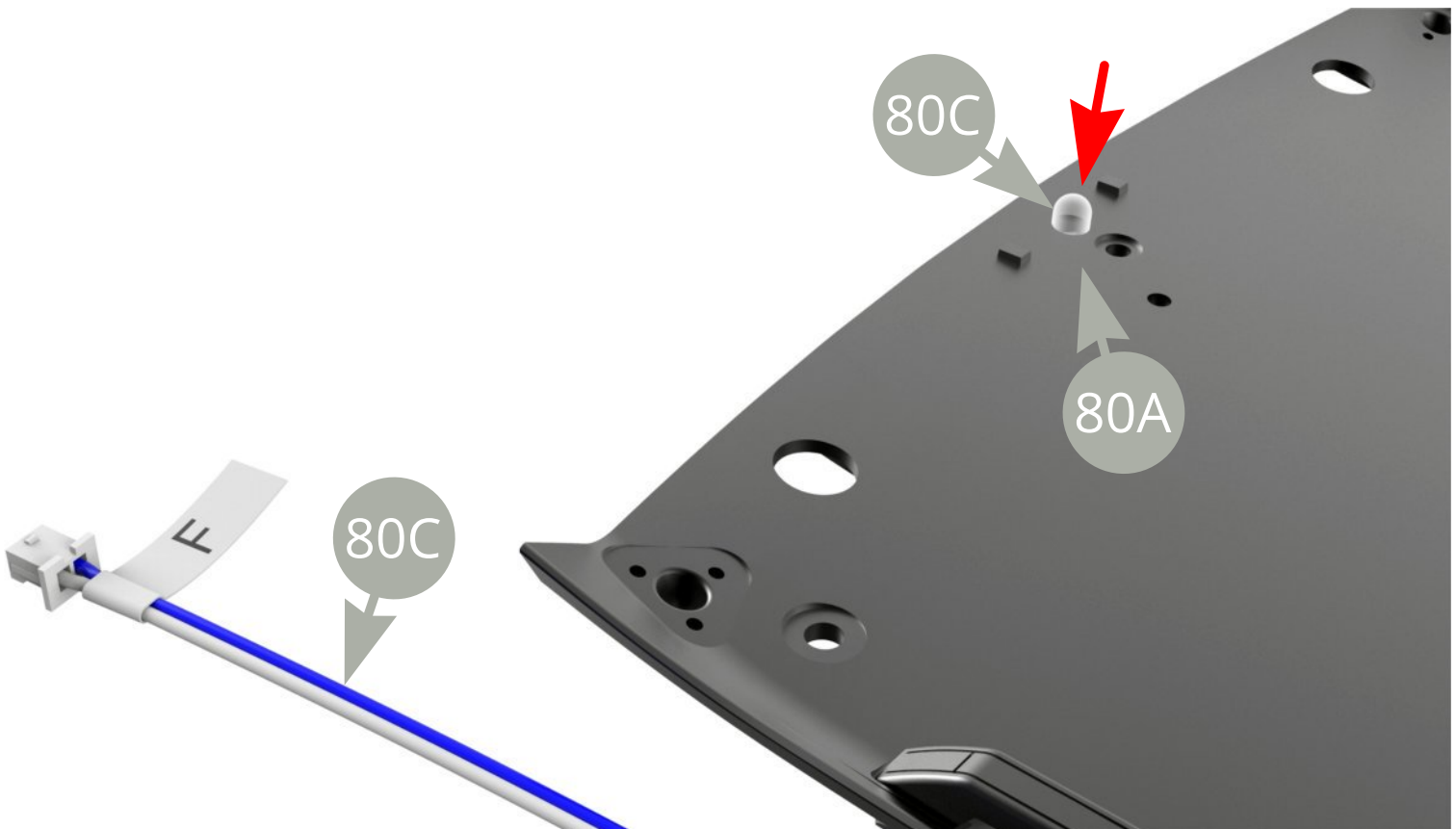

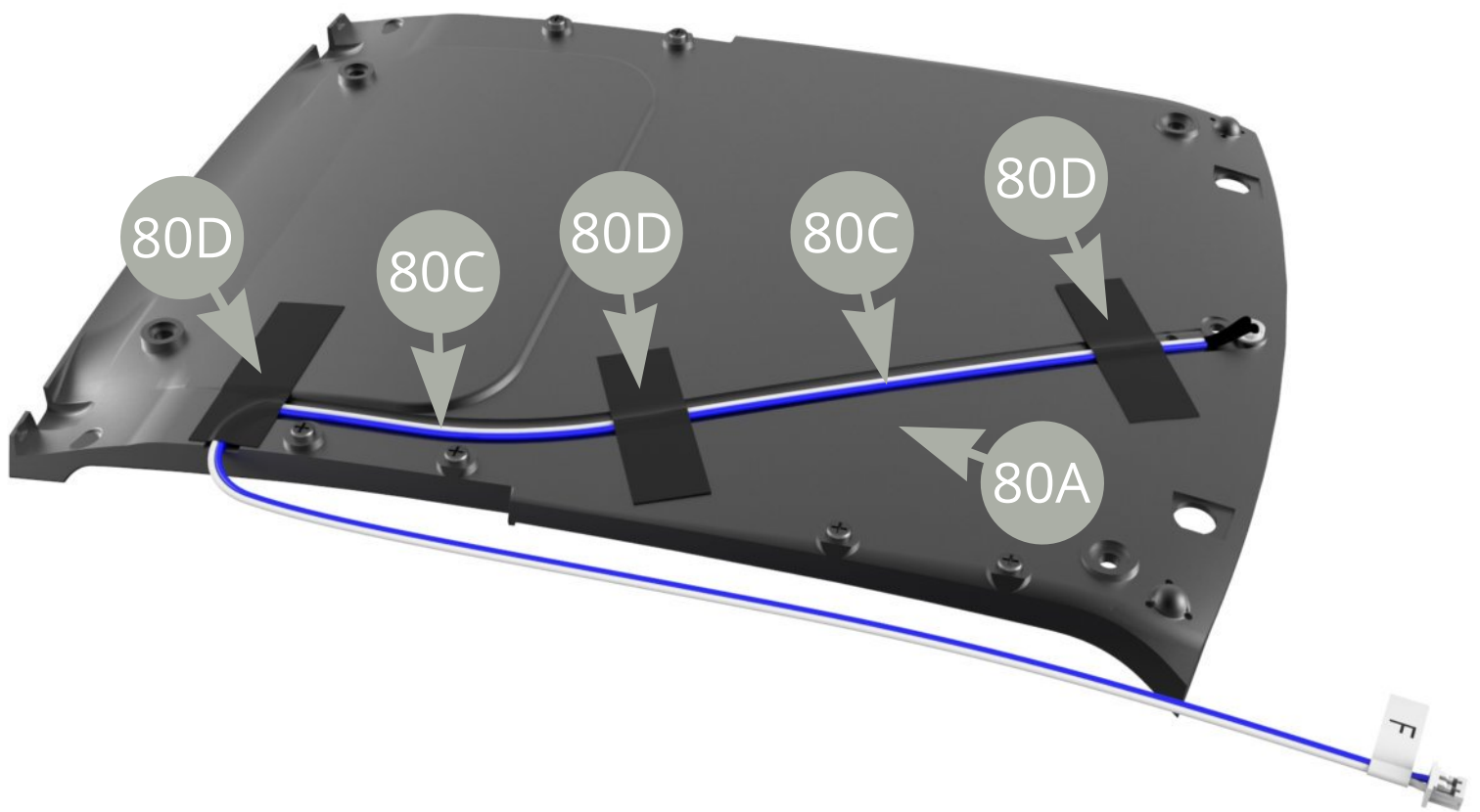

Lead **80C Interior lamp cable F** along the groove on **80A Ceiling lining** and fix with three **80D tape** pieces .

Final views .

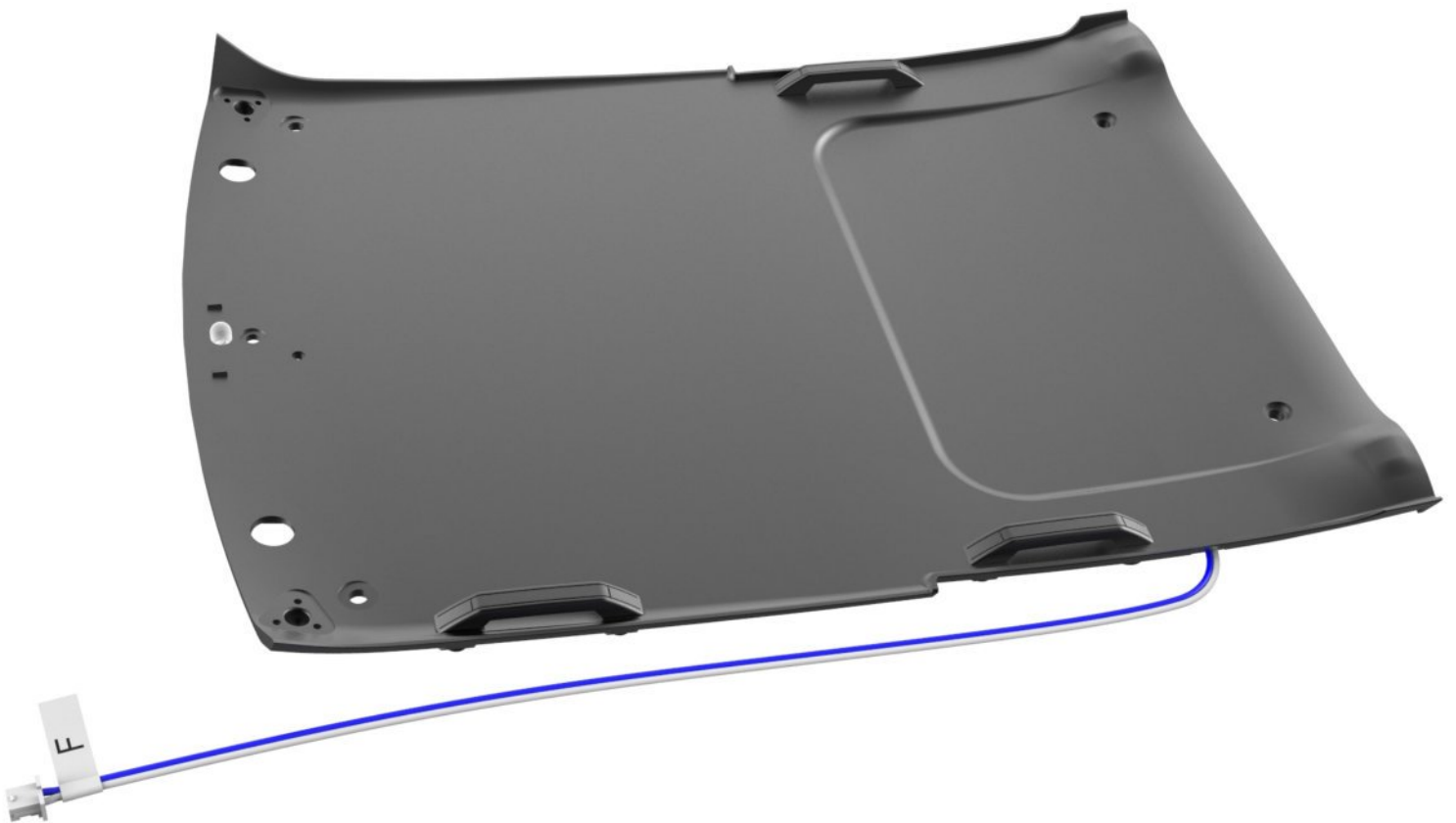
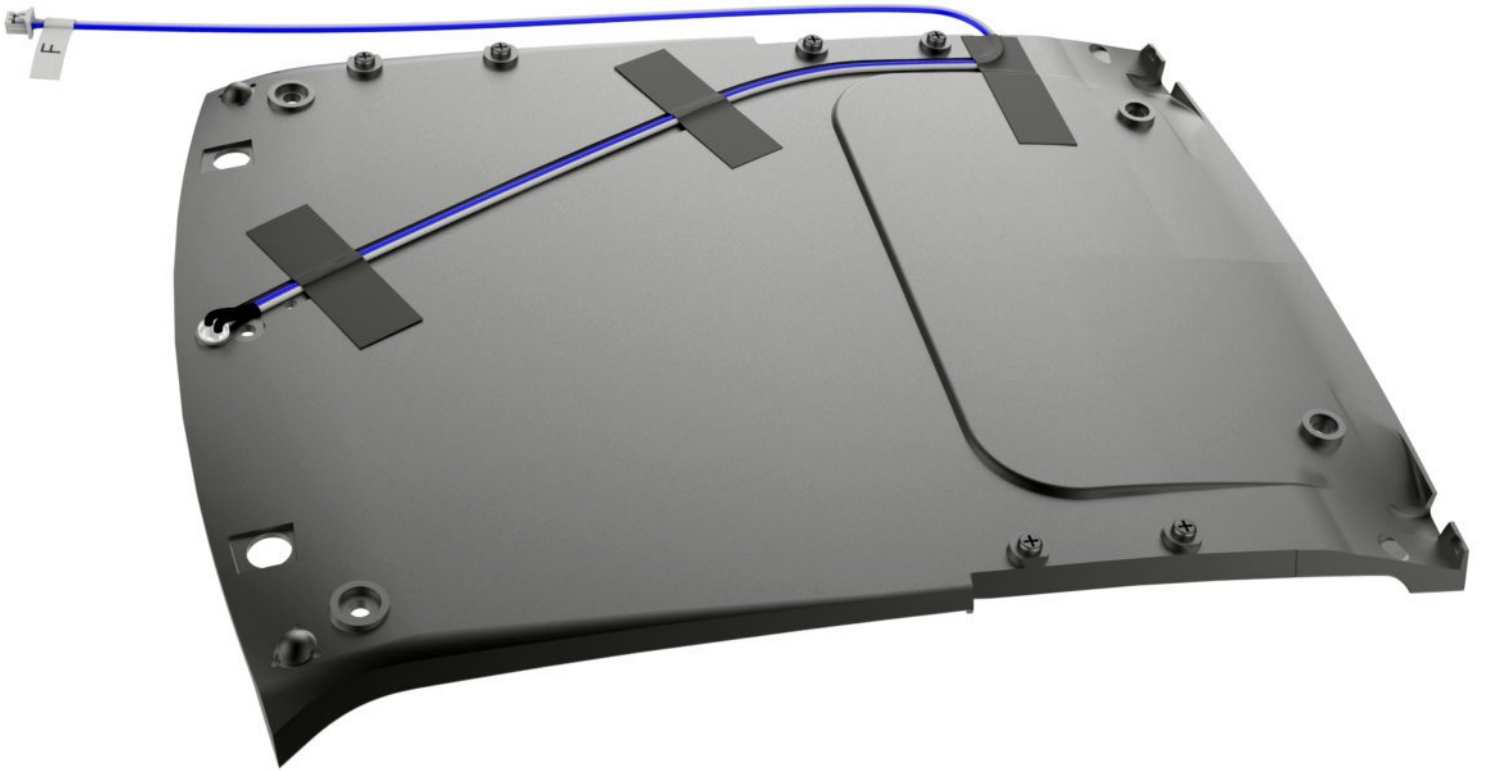

# Assembly drawings .

